

Zips 3.0

Micro Plunger & Dual Micro Plunger Sensors
ZB2008 & ZB2009

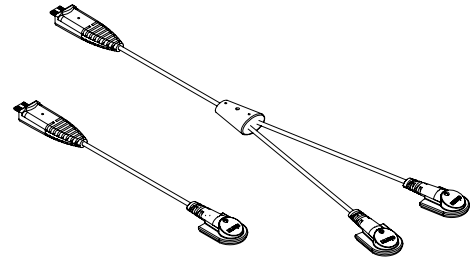

1 Use the provided alcohol wipe to clean an area on the merchandise where the sensor(s) will be placed. Allow it to dry completely.

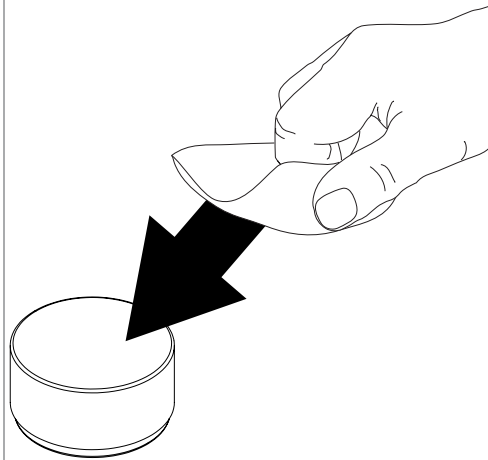

2 Peel the clear film from the adhesive(s) on the sensor(s).

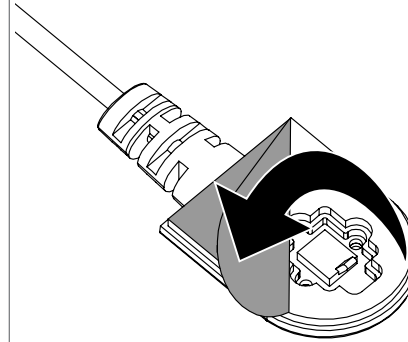

3a Place the sensor onto the merchandise and apply pressure for at least 10 seconds.

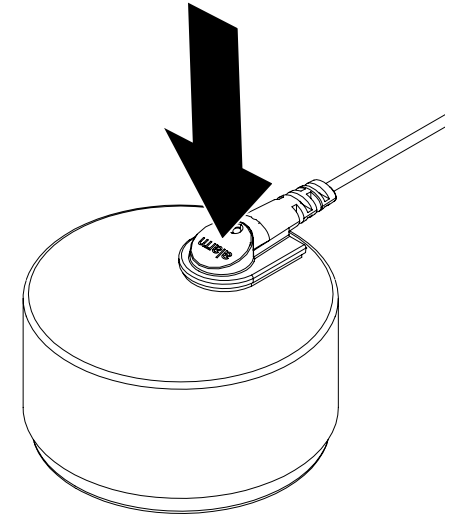

3b If using the Dual Plunger version (ZB2009):
Each sensor should be placed onto different parts of the merchandise that could be separated. Apply pressure for at least 10 seconds.

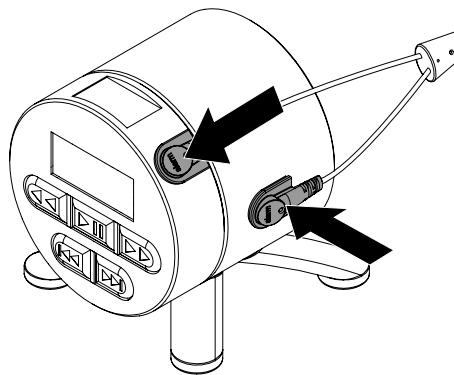

4 Plug the sensor into the previously installed alarm unit.

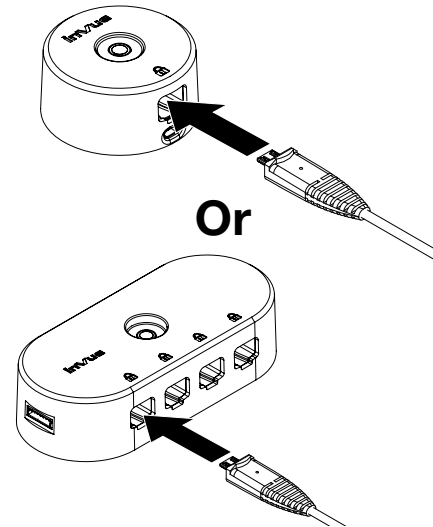

5 To remove the sensor from the alarm unit; use a charged and coded key to deactivate the unit, then place the magnet key onto the lock icon on alarm unit above the sensor. Push in slightly and unplug the sensor.

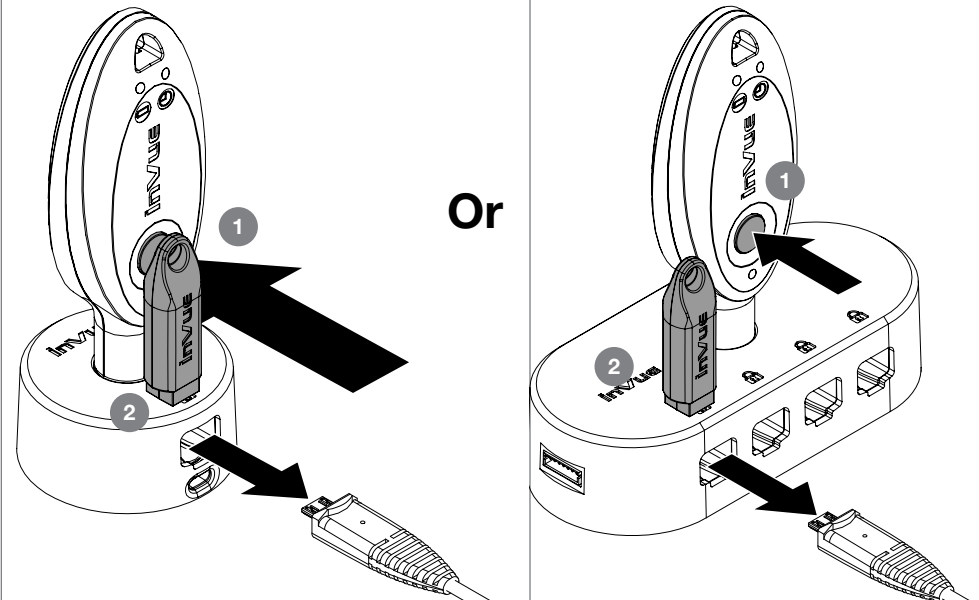

Note: This sensor is also compatible with S2865 Power/Alarm boxes, OnePOD & S960 aux ports, Zips Power Multiport & Zips 2.0.



SD0642 Rev0 02/21/19



SABEL

P 1300 551 662

E info@sabel.com.au