

**inVue**

**SABEL**

# Smart Lock

Showcase Lock + Door Brace

*(For Double Swing-Out Doors)*

PL401 + PL420-01

sabel.com.au

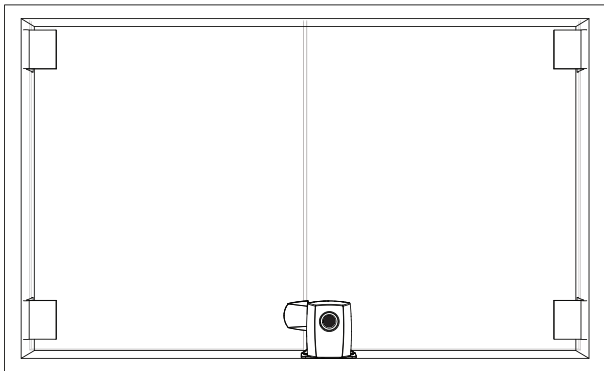

## Overview

Review entire instruction guide before starting installation. Instructions are intended for double swing-out panel door applications.

## Lock & Cabinet Specification

The Showcase Lock is designed primarily for wood cabinets with glass swing-out doors. The lock can also be affixed to wood or metal doors. Panel door thickness can range from 4.8 mm – 6.35 mm (0.19" – 0.25"). Wall thickness of the cabinet structure must be greater than 12.7 mm (0.5").

## System Components

1. Showcase Lock (PL401)
2. Base Plate & Base Plate Template (*included*)
3. Alcohol Wipe (*included*)
4. Door Brace (PL420-01) (*sold separately*)
5. IR2 Key (PK4400)

## Tool Requirements

1. Pencil
2. Power Drill and Bit
3. Small Router/Dremel Tool
4. Phillips #1 Screwdriver

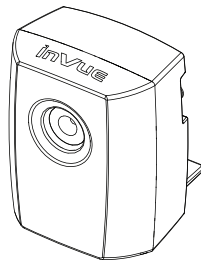

**Showcase Lock**  
PL401

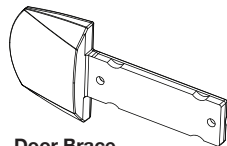

**Door Brace**  
PL420-01

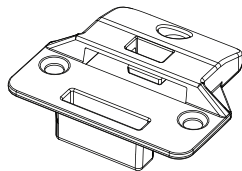

**Base Plate**  
(*included with PL401*)

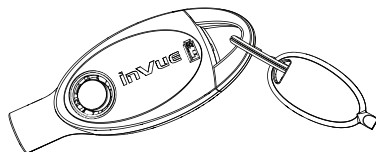

**IR2 Key**  
PK4400

## LOCK ASSEMBLY

Lock should be positioned on swing-out end of panel door (opposite hinges).

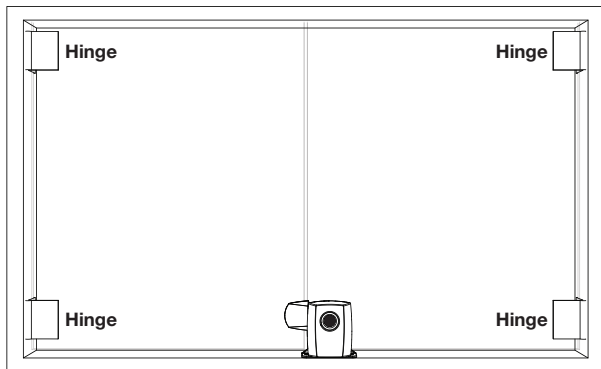

## SABEL

- 1 Determine location of lock. Align template with front of glass and mark drill holes and routed pocket to assemble lock base. **Important: Place template flush with door edge.**

Note: Illustrations below shows top view of cabinet.

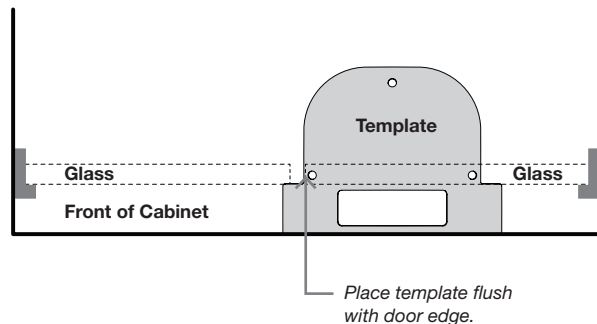
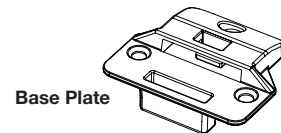

Tip: Base plate and lock should be positioned close to swing-out end of door panel. Base plate template should be positioned no further forward than front edge of cabinet.

**2**

Use router tool to create pocket a minimum depth of 12.7 mm (0.5"). Use a 2 mm (0.08") drill bit for 3 screw holes. **Caution: Do not drill holes through cabinet walls.**

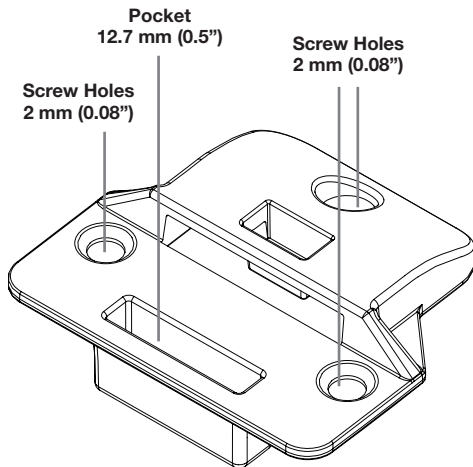
**3**

Attach base plate to cabinet with 3 wood screws provided and a screwdriver. Bottom of base plate should be flush with flat surface of cabinet. If not flush, detach base plate and remove more wood material from rectangular pocket.

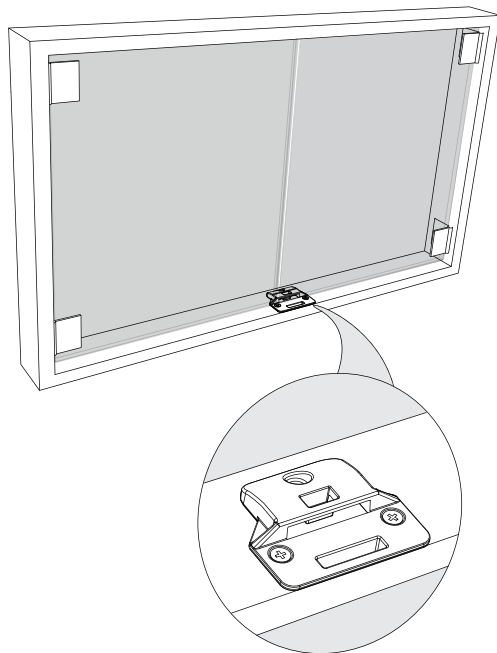

- 4** Wipe front of panel with alcohol wipe where you intend to mount lock. **Allow alcohol to air dry for a minimum of 5 minutes or dry alcohol with lint free cloth before moving to step 5.**

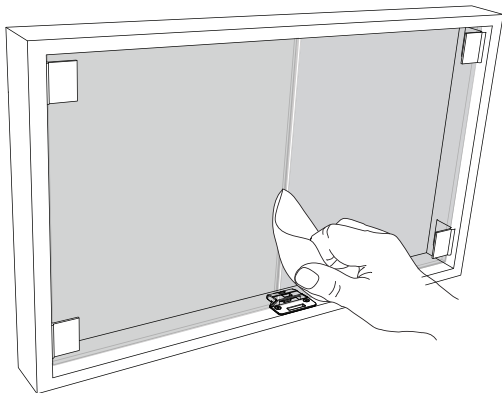

**STOP!  
WAIT 5 MINUTES!**

- 5** Remove back spacer. Place new door brace (PL420-01) onto lock (PL420) using original screws.  
*Note: Door brace can be positioned on left or right side of lock. Images shown below without adhesive attached to back spacer or door brace for illustration purposes only.*

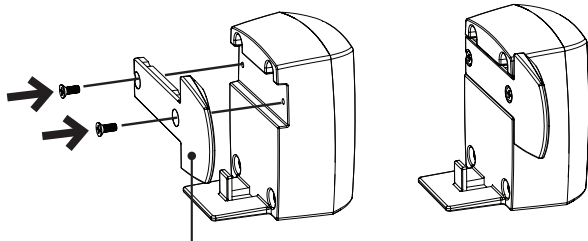
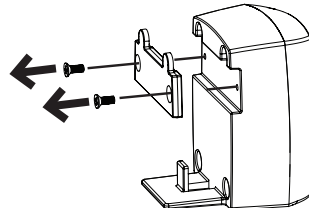

**Door Brace**

**6**

Slide lock body onto glass panel. Close glass panel and test fit lock body into base plate. Confirm proper fit/alignment.

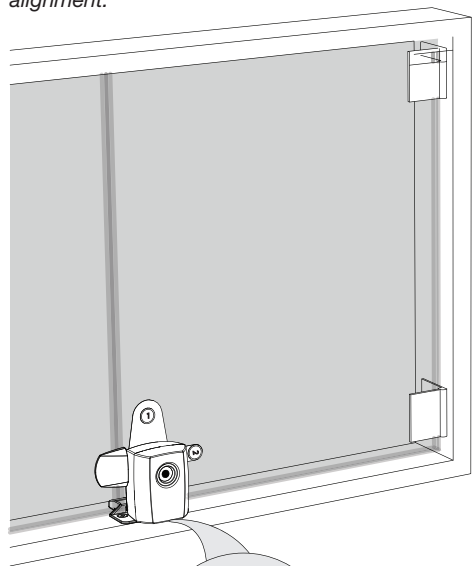

Base Plate

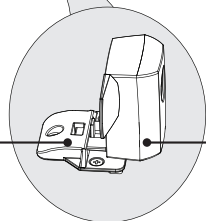

Lock Body

**7**

Lightly hold lock body in position and remove numbered tabs in order (#1 then #2). Press lock against glass panel for at least 10 seconds.

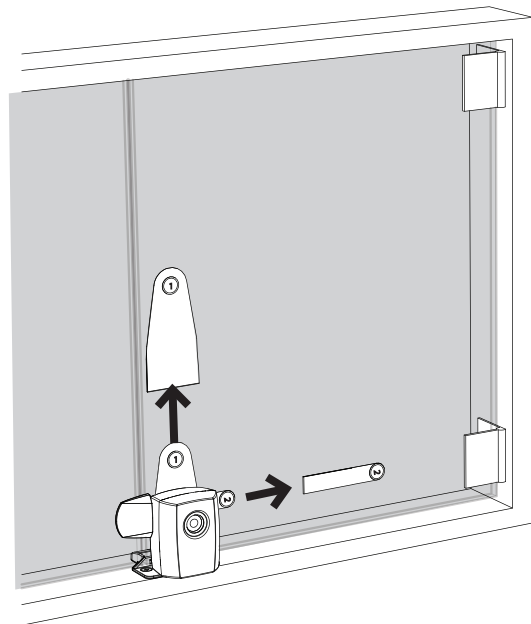

8

Test lock to confirm proper function. Use IR2 Key to lock/unlock installation (see page 13).

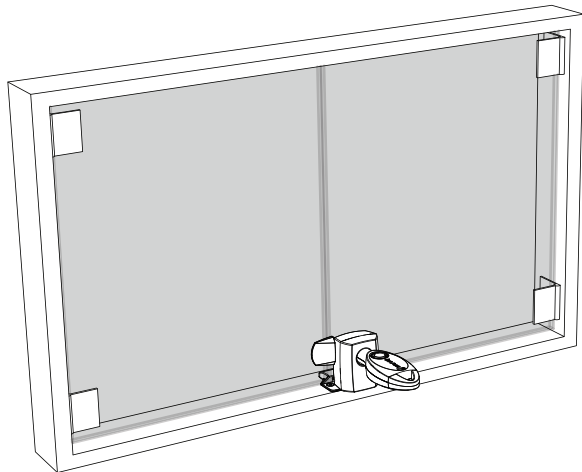

**SABEL**

## LOCK OPERATION USING IR2 KEY

Position IR2 Key against lock, push button and wait for "beep" before removing key. Lock and unlock cabinets several times to ensure proper operation.

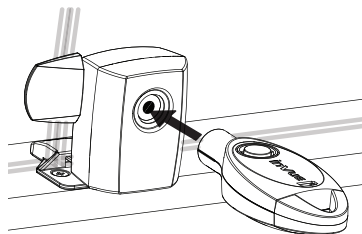

IR2 Key must be charged and activated. See IR2 Key instruction guide.

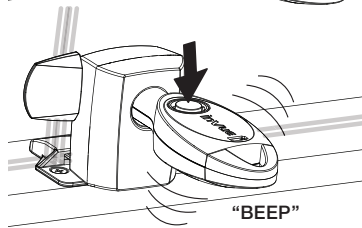

Hold until you get a confirmation "beep." Note: If double "buzz," an error has occurred. Unlock, ensure cabinet is fully closed and try again.

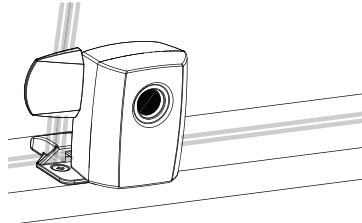

Locked

## LOCK STATUS INDICATORS

SABEL

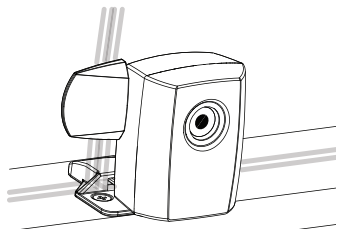

Unlocked

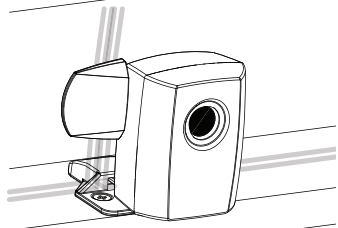

Locked

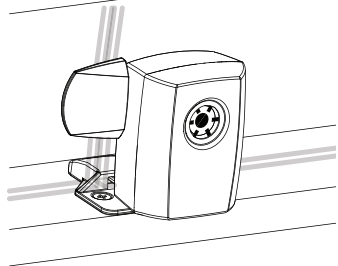

**Error (not fully locked)**  
Note: Unlock lock. Confirm no obstructions. Fully close cabinet and try again.



# SABEL

1300 551 662

[info@sabel.com.au](mailto:info@sabel.com.au)