

Above Counter

### System Overview

Below Counter

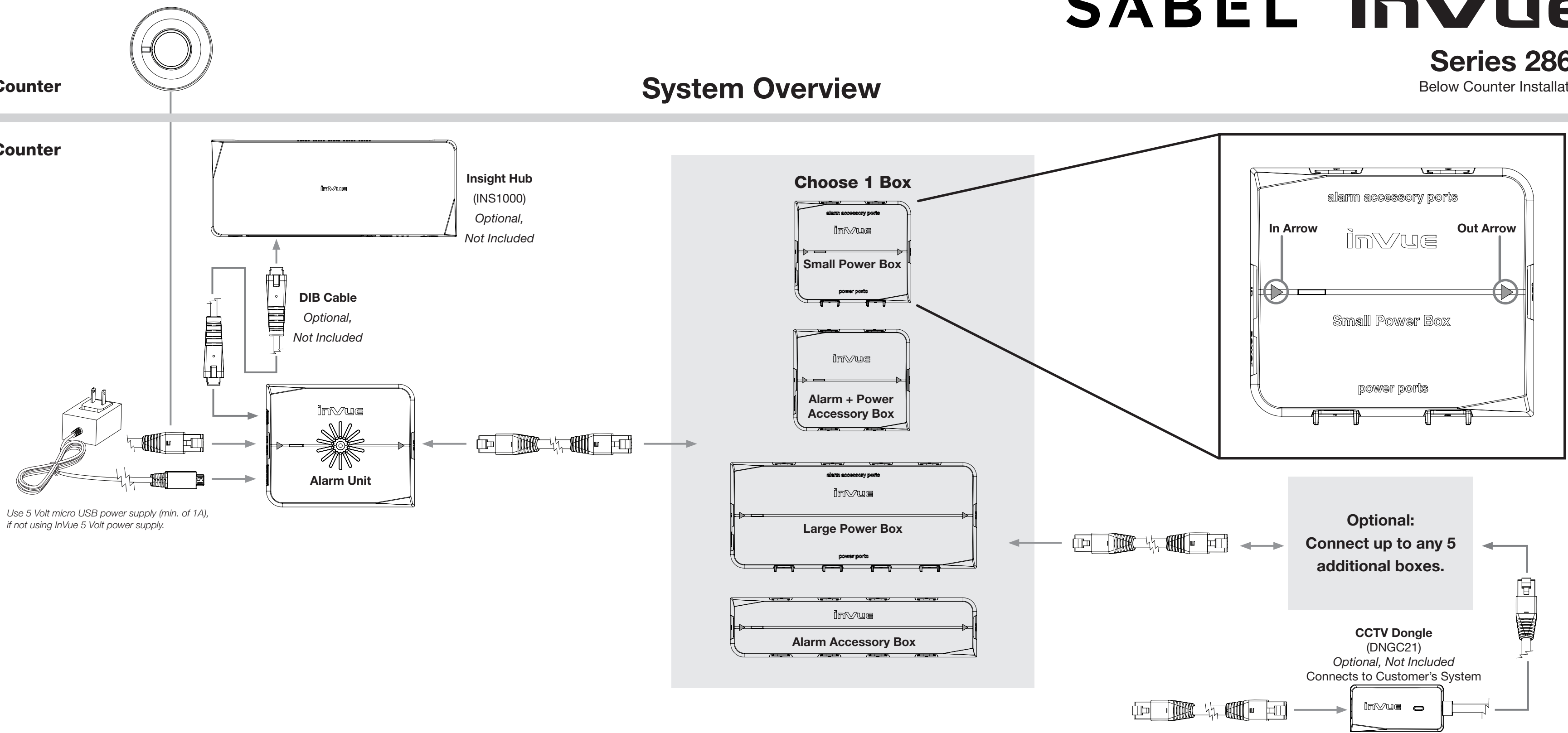

### Parts List

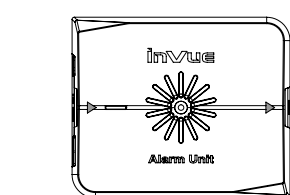

**Alarm Unit**  
DKGU01  
DKGU02  
(5 Volt Micro USB Power Supply required)

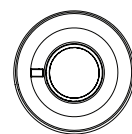

**IR Dot**  
(Shipped with Alarm Unit)

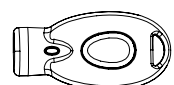

**IR Key**  
AF4400  
PK4400  
AK4400

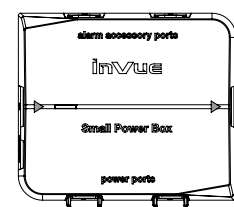
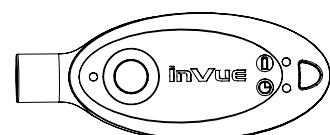

**Small Power Box**  
DKPB02  
(18 Volt or 24 Volt Power Supply required)

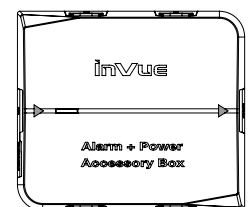

**Alarm + Power Accessory Box**  
DKPW04  
(5 Volt Power Supply required)

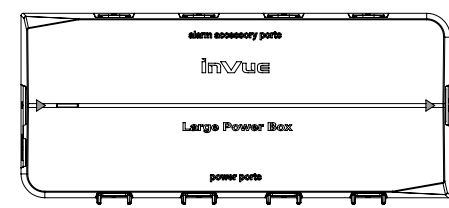

**Large Power Box**  
DKPB04  
(18 Volt or 24 Volt Power Supply required)



**Alarm Accessory Box**  
DKPX08  
(No Power Supply required)

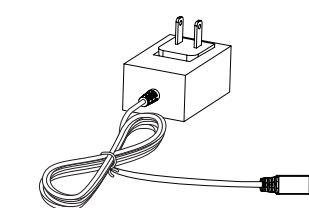

**5 Volt Micro USB Power Supply**  
US PS512-US  
EU PS512-EU  
UK PS512-UK  
AUS PS512-AUS  
ARG PS512-ARG

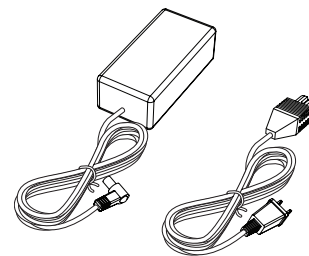

**18 Volt Power Supply**  
US SNYP00B  
EU SNYP01B  
UK SNYP02B  
AUS SNYP03B

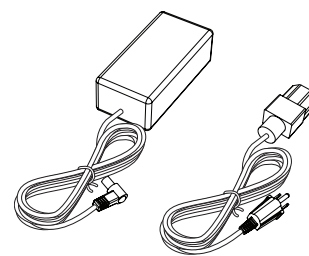

**24 Volt Power Supply**  
US SNZP00B  
EU SNZP01B  
UK SNZP02B  
AUS SNZP03B

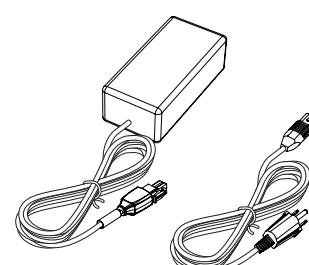

**5 Volt Power Supply & Cable**  
US YLR52 & YC9  
EU YLR52 & YC11  
UK YLR52 & YC10  
AUS YLR52 & YC12

### LED Behavior

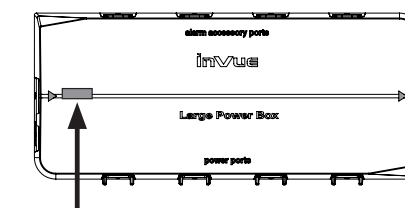

**Green LED = Good**  
**Red LED = Not enough power**  
(Use 24 Volt Power Supply)  
**No LED = Error, No Power**

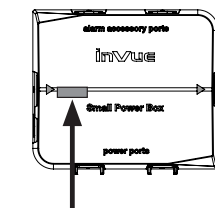

**Green LED = Good**  
**Red LED = Not enough power**  
(Use 24 Volt Power Supply)  
**No LED = Error, No Power**



**Green LED = Good**  
**No LED = Error, No Power**

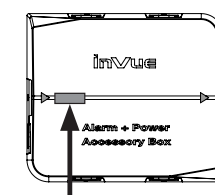

**Green LED = Good**  
**No LED = Error, No Power**

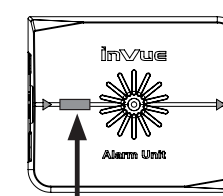

**Green LED = Good**  
**Flashing Green LED = Alarming**  
**No LED = Error, No Power, or System not coded**

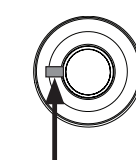

**Gold or Blue LED = Good**  
**Flashing Gold or Blue LED = Alarming**  
**No LED = Error, No Power, or System not coded**

# Installation Steps

- 1 ABOVE COUNTER**  
Wipe surface with alcohol wipe.
- 2a** Remove adhesive cover and apply IR Dot to surface. Run cable to Alarm Unit.
- 2b** *Optional:* Remove adhesive cover and feed IR Dot cable through 15 mm hole and apply IR Dot to surface.
- 3 BELOW COUNTER**  
Plug IR Dot cable into the side of the Alarm Unit with the "In" arrow.
- 4** *Optional:* Screw mount\* (screws included) or adhesive mount (ADH2040) alarm unit. See the screw hole dimensions below.
- 5** Plug the cable into the "Out" arrow side of the Alarm Unit.
- 6** Plug cable from Alarm Unit into the "In" arrow side of box 1.
- 7** *If using power box:* Plug 18V or 24V power supply into box.
- 8** Plug power supply into outlet.
- 9** *Optional:* Screw mount\* (screws included) or adhesive mount (ADH2040) the large power box. See the screw hole dimensions below.
- 10** *Optional:* Repeat to add up to 5 additional boxes.
- 11** Plug in 5V Power Supply.
- 12 ABOVE COUNTER**  
Place a charged and coded IR3 Key on the IR dot and press the button to code the system.
- 13** *Optional:* Connect an insight hub to the alarm unit.

## Screw Mount Dimensions

ALARM UNIT

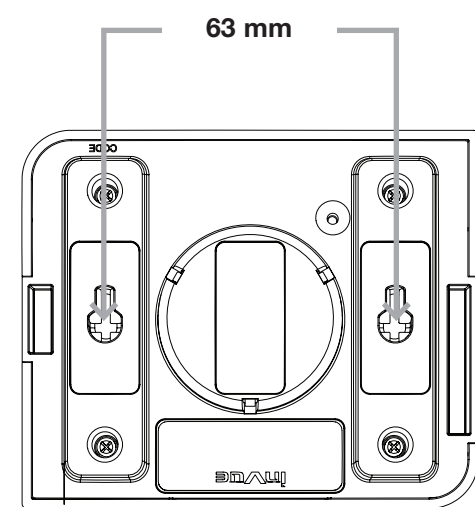

DKGU01 & DKGU02

ALARM ACCESSORY BOX

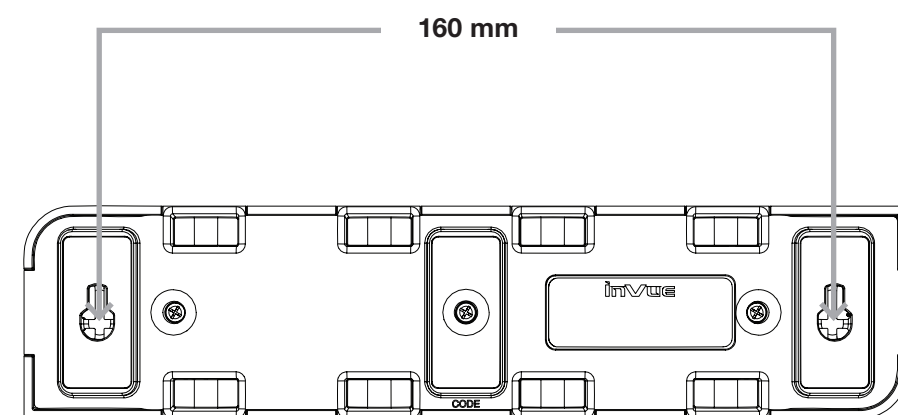

DKPX08

SMALL POWER BOX & ALARM + POWER ACCESSORY BOX

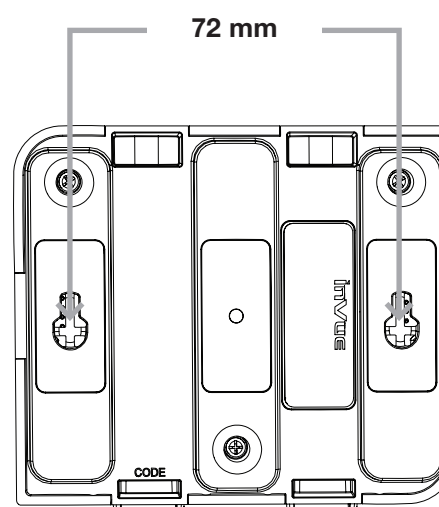

DKPB02 (Small Power Box)  
DKPW04 (Alarm + Power Accessory Box)

LARGE POWER BOX

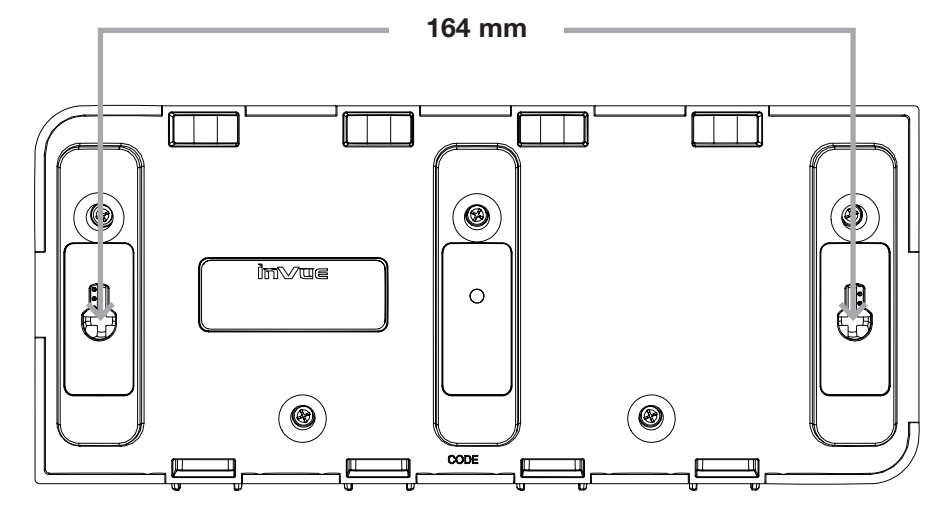

DKPB04

# SABEL

